

Flood Sensor SAYA-FS-LI915



Features Include

- ⇒ Flood sensing under appliances and fixtures
- ⇒ Sends alerts for leaks and low battery
- ⇒ FCC certified transmission
- ⇒ One year warranty

Specifications

- | | | | |
|-------------------------|--------------------|--------------------|----------------------|
| ⇒ LAN Transmission | : Lora 915 Mhz | ⇒ Max working temp | : 115 ⁰ F |
| ⇒ Max Range (OTA, LOS) | : 1 miles | ⇒ Power | : Battery CR2450 |
| ⇒ Enclosure Material | : Plastic (Indoor) | ⇒ Antenna | : Internal |

Installation Recommendation

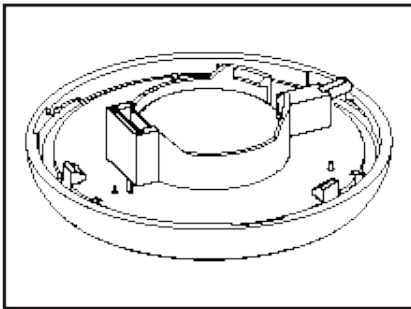

Remove the top section

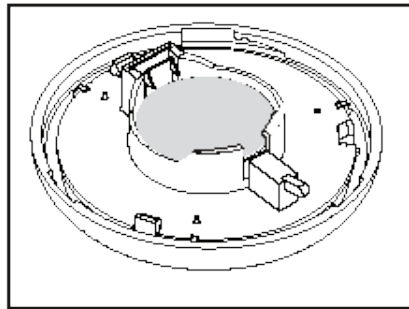

Insert the battery

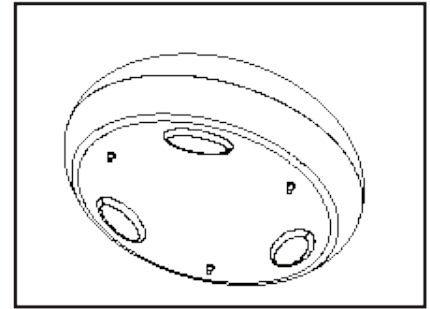

Close the top section

Attention

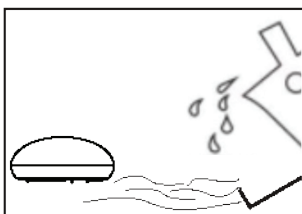

Put the product where there is a high risk or water leakage

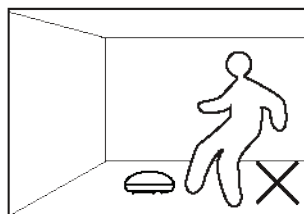

Please do not place the products in the passing lanes

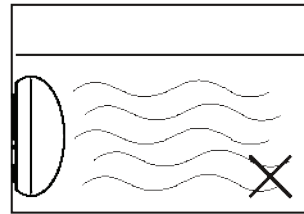

Please do not submerge the sensor in water

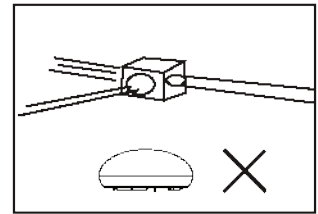

Please do not place the sensor by corrosive or magnetic fields